

3.3 Scope of delivery

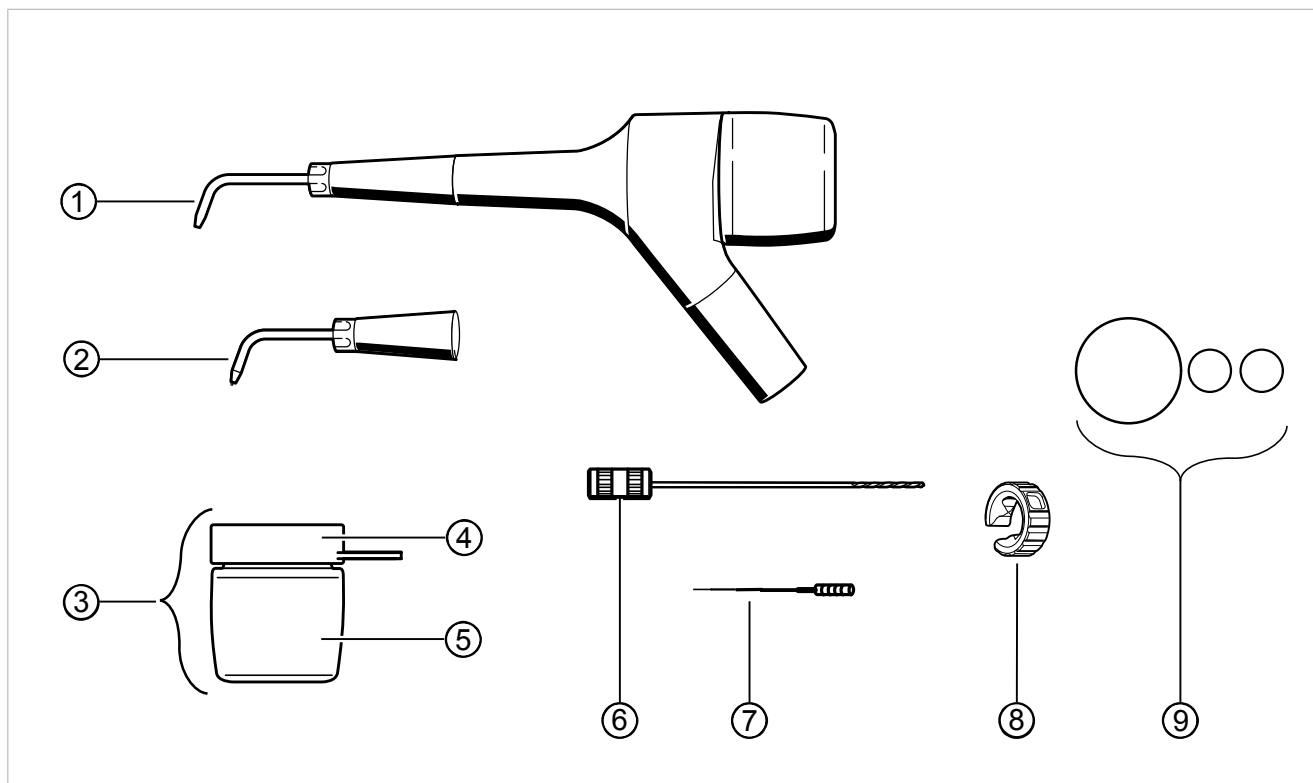













The set consists of:

No./ Item no.	Description	Mat. No.
1 x ①	PROPHYflex 4 with: Long gripping sleeve Cannula Powder container	3.003.0520 3.003.1138 3.002.8136
1 x ②	Short gripping sleeve Power cannula	3.003.2607 3.005.0077
1 x ③	Powder container ⑤ Rubber cover supra ④	3.002.8136 3.004.4708
1 x ⑥	Cleaning bur	3.004.9870
1 x ⑦	Nozzle needle	0.573.6052
1 x ⑧	Wrench for cannula	3.004.6351
1 x ⑨	O-rings for powder container and coupling interface to the gripping sleeve	can be ordered individually See also: 📄 8 Consumables, Page 32

8 Auxiliary equipment

Available from dental suppliers.

Cannula		Mat. no. 3.003.1138
Power cannula		Mat. no. 3.005.0077
Powder container		Mat. no. 3.002.8136
Rubber cover supragingival		Mat. no. 3.004.4708
Rubber cover subgingival		Mat. no. 3.004.4709
Cleaning bur		Mat. no. 3.004.9870
Nozzle needle		Mat. no. 0.573.6052
Nozzle		Mat. no. 3.004.2324
Long gripping sleeve		Mat. no. 3.003.0520
Short gripping sleeve		Mat. no. 3.003.2607
Cleaning adapter PROPHYflex 4 long		Mat. no. 3.004.6640
Cleaning cover PROPHYflex 4		Mat. no. 3.004.6658
Cleaning adapter PROPHYflex 4		Mat. no. 3.004.8509
Cleaning adapter PROPHYflex 4 S		Mat. no. 3.004.8523
PROPHYflex 4 Perio Kit	Accessories for PROPHYflex for subgingival bio-film removal and cleaning of implant surfaces, crowns and bridges	Mat. no. 1.011.9403
Refill PROPHYflex perio tip (Kit for refilling the PROPHYflex 4 Perio Kit (1.011.9403)	Mat. no. 1.011.9403